

- > **Soft-Start/Stop Controller and SSR in One Package**
- > **Microcontroller Based Technology**
- > **Adjustable Ramp Rates**
- > **Low Voltage, 4-20mA, or Potentiometer Control**
- > **LED Status Indicator**
- > **SCR Based Output Load Switching**
- > **Built-In Internal Snubber**



GENERAL SPECIFICATIONS

Dielectric Strength 50/60Hz, Input/Output/Base	4000 Vrms
Insulation Resistance (Min.) @ 500 Vdc	10 ⁹ Ohm
Max. Capacitance Input/Output	10 pF
Ambient Operating Temperature Range	-20 to 80°C
Ambient Storage Temperature Range	-40 to 125°C

MECHANICAL SPECIFICATIONS

Weight: (typical)	3.0 oz. (86.5g)
Encapsulation	Thermally Conductive Epoxy
Terminals - Power	Screws and Saddle Clamps Furnished, Unmounted
Control	Barrier Strip Screw Terminals

OUTPUT SPECIFICATIONS

	Voltage Suffix		
	12	24	48
Operating Voltage (47-63 Hz) [Vrms]	48-140	180-280	300-530
Transient Overvoltage [Vpk]	400	600	1200
Max. Off-State Leakage Current @ Rated Voltage [mA]	5	7	12
Power Factor (Min.) with Max. Load	0.5	0.5	0.5
Maximum Voltage Drop (100% On) [Vpk]	1.6	1.6	1.6
Minimum Off-State dv/dt [V/μsec]	200	200	200
	Current Suffix		
	25 Amp	50 Amp	90 Amp
Max. Load Current [Arms]	25	50	90
Min. Load Current (mArms)	150	150	150
Max. Surge Current (16.6ms) [Apk]	250	625	1200
Thermal Resistance Junction to Case (R _{θJC}) [°C/W]	1.02	0.63	0.28
Maximum I ² t for Fusing, (8.3 msec.) [A ² s]	260	1620	6000
	ST	SP	SS
Max. Turn-On Time High Level P3	Adjustable	1/2 Cycle	Adjustable
Max. Turn-Off Time High Level P3	1/2 Cycle	Adjustable	Adjustable

INPUT SPECIFICATIONS*

	Minimum	Typical	Maximum
DC Voltage Supply Range [Vdc] [P1]	8	12	32
Input Current [mA]	28		30
Control Must Operate Voltage "ON" [Vdc][P3]	5		32
Control Must Release Voltage "OFF" [Vdc][P3]	0		4
Input Current [mA] [P3]	0		2.6
Analog Range Option A [Vdc][P4]	0.5		5
Analog Range Option B [Vdc][P4]	1.25		7
Analog Range Option C [Vdc][P4]	2		10
Analog Range Option D [mA][P4]	4		20
Nominal Input Impedance Option A,B,C [Ohms][P4]		20K	
Nominal Input Impedance Option D [Ohms][P4]		220	

*Voltages are reference to GND (Ground = 0Vdc) P2

The MCST, MCSP and MCSS series of controls is designed to provide adjustable surge reducing soft-start and soft-stop control for any load which would benefit from a gradual application or shutdown of power, and provide Crydom SSR switching within one package.

The MCS Controls are available with either soft-start, or soft-stop functions separately, or as a combined soft-start/soft-stop control. With adjustable ramp times from 100ms to 10 seconds in two ranges, these controls are ideal for reducing starting current surges in motors, in preventing saturation when switching transformers, or in reducing reverse EMF surges when de-energizing large inductive loads. Incorporating 4000 volt isolation from input to output, the MCS series allows real time adjustment of the ramp rates from a remote source using analog voltage or current control. Once the desired ramp rate is set using the analog input, a simple digital signal applied to the ON/OFF control input will operate the control. The MCS is also available with a built-in potentiometer for use where remote or continuous adjustment is not needed.

Part Number Nomenclature

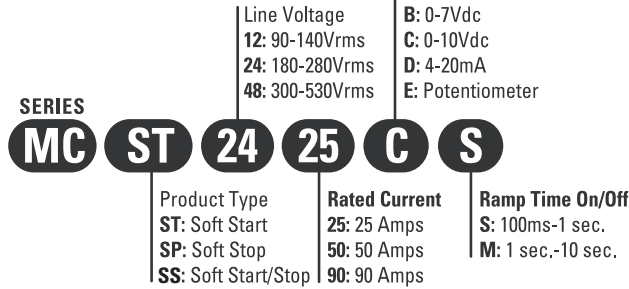

Output Status Functions

CONDITIONS	LED
Initial Logic Supply On	Flash Once
Load Voltage Missing / Load Open (w/control P3 disabled)	Flash Once Intermittently
Load Voltage Present (w/control P3 enabled)	Off
Ramp Time (Soft Start upon P3 Enable)	Off to Bright
Ramp Time (Soft Start upon P3 Disable)	Bright to Off
Output ON (Normally Steady Operation)	On

Electrical Connections

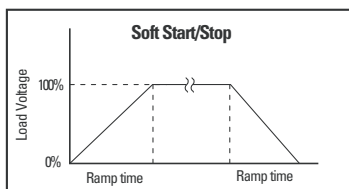
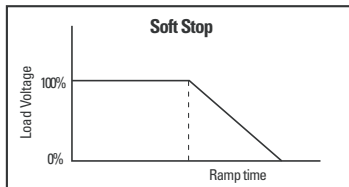
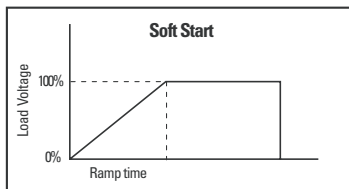
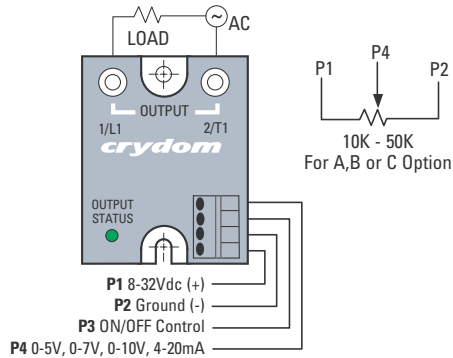

Mechanical

Dimensions are in inches (millimeters)

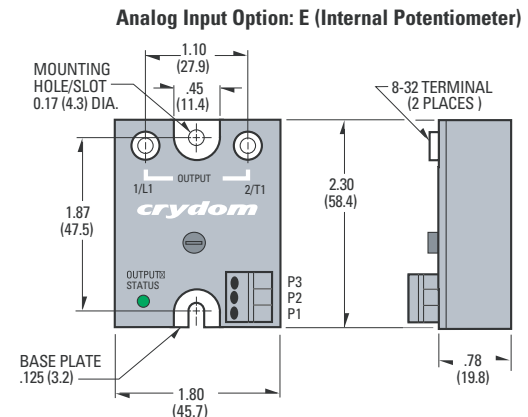
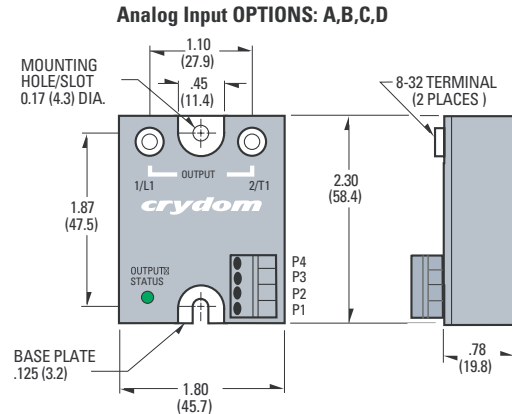

Screw Torque Requirements:

8-32 Screws - 20in. lbs. (Screws dry without grease.)
Input Connections via Screw Type Barrier Strip

Ramp Time in Seconds

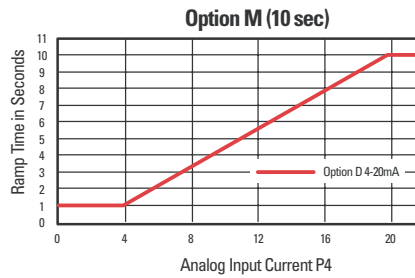
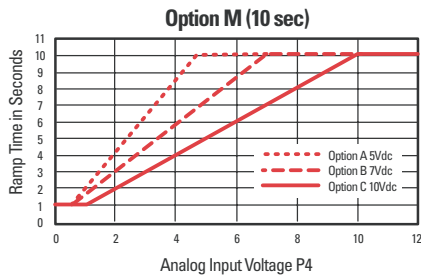
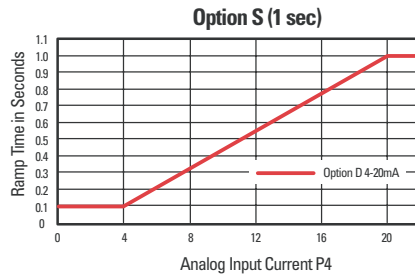
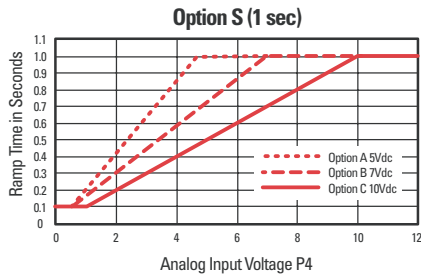

Current Derating Curves

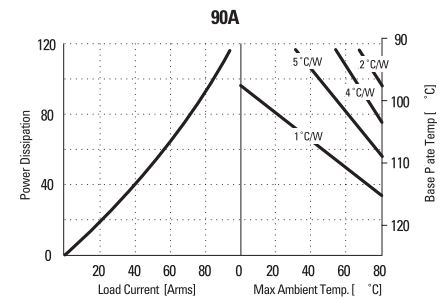
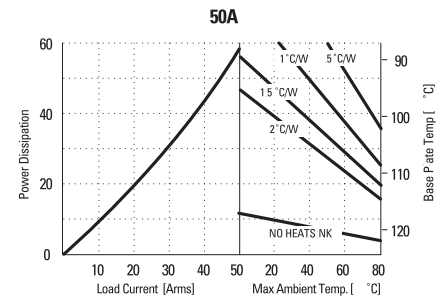
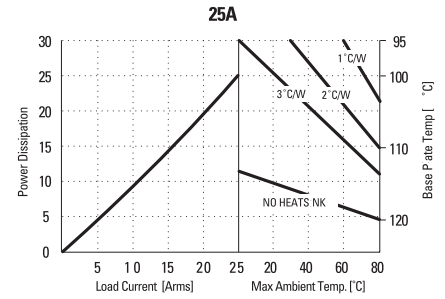

ISO9001 Certified

Approvals

UL - Pending

USA

Sales Support (877) 502-5500
 Tech Support (877) 702-7700
 Fax (619) 710-8540
 Email: sales@crydom.com
 Crydom Corp
 2320 Paseo de las Americas, Suite 201
 San Diego, CA 92154

EUROPE - UK

Telephone +44 (0) 1202 365070
 Fax +44 (0) 1202 365090
 Email: intsales@crydom.com
 Crydom International Ltd.
 7 Cobham Road
 Ferndown Industrial Estate
 Wimborne, Dorset BH21 7PE

Germany

Telephone +49 (0) 180 3000 506

ASIA - Thailand

Telephone +66 (0)2 665 2517
 Fax +66 (0)2 665 2588
 Crydom Asia
 18/8 Fico Place 12th Floor
 Soi Sukhumvit 21 (Asoke)
 Klongtoey Nua, Wattana
 Bangkok, Thailand 10110